

Article number: 12308100060110  
Description: KLEE-coil 308 100 060.110  
M6 Hardened/zinc-plated Blue

## Measures

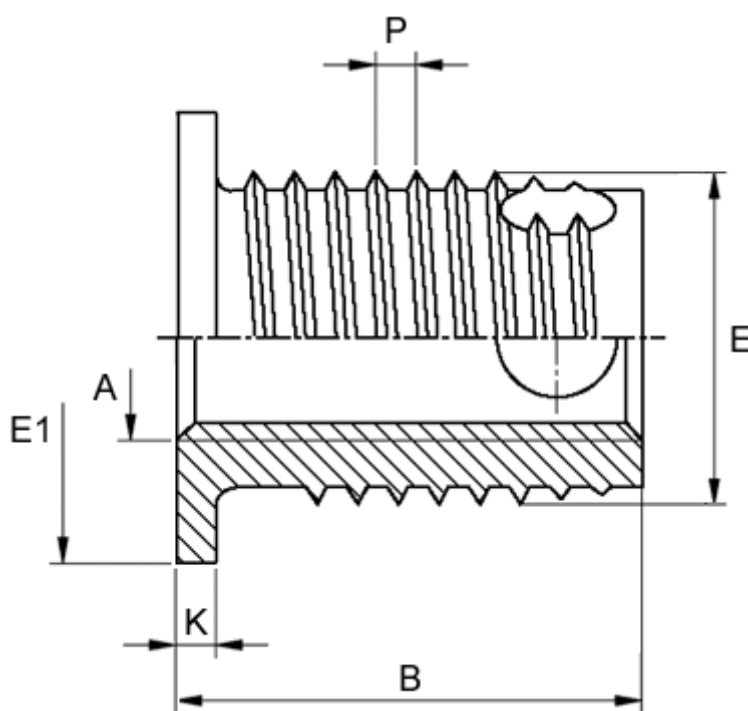

Female thread A	= M6
Flange diameter E1	= 13
Flange height	= 1.5
Length B	= 13.5
Male thread E	= 10
Min hole depth blind hole	= 15
Thread pitch P	= 1.25
Type	= 308 100 060 ...